

□ 回路図 : CIRCUIT

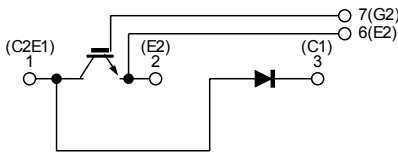

□ 外形寸法図 : OUTLINE DRAWING

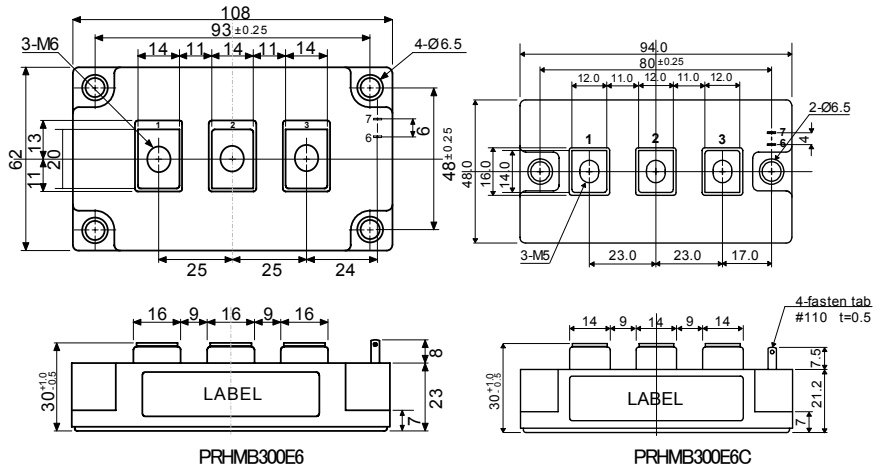

Dimension: [mm]

□ 最大定格 : MAXIMUM RATINGS (T_c = 25°C)

Item	Symbol	Rated Value	Unit	
コレクタ・エミッタ間電圧 Collector-Emmitter Voltage	V _{CEs}	600	V	
ゲート・エミッタ間電圧 Gate-Emmitter Voltage	V _{GES}	±20	V	
コレクタ電流 Collector Current	DC	I _C	A	
	1ms	I _{CP}		600
コレクタ損失 Collector Power Dissipation	P _C	1,040	W	
接合温度 Junction Temperature Range	T _j	-40~+150	°C	
保存温度 Storage Temperature Range	T _{stg}	-40~+125	°C	
絶縁耐圧(Terminal to Base AC, 1 minute) Isolation Voltage	V _{ISO}	2,500	V (RMS)	
締め付けトルク Mounting Torque	Module Base to Heatsink Busbar to Main Terminal	PDMB3006	3 (30.6)	N·m (kgf·cm)
		PDMB300E6C	3 (30.6) 2 (20.4)	

□ 電気的特性 : ELECTRICAL CHARACTERISTICS (T_c = 25°C)

Characteristic	Symbol	Test Condition	Min.	Typ.	Max.	Unit
コレクタ遮断電流 Collector-Emmitter Cut-Off Current	I _{CEs}	V _{CE} = 600V, V _{GE} = 0V	-	-	1.0	mA
ゲート漏れ電流 Gate-Emmitter Leakage Current	I _{GES}	V _{GE} = ±20V, V _{CE} = 0V	-	-	1.0	μA
コレクタ・エミッタ間飽和電圧 Collector-Emmitter Saturation Voltage	V _{CE(sat)}	I _C = 300A, V _{GE} = 15V	-	2.1	2.6	V
ゲートしきい値電圧 Gate-Emmitter Threshold Voltage	V _{GE(th)}	V _{CE} = 5V, I _C = 300mA	4.0	-	8.0	V
入力容量 Input Capacitance	C _{ies}	V _{CE} = 10V, V _{GE} = 0V, f = 1MHz	-	15,000	-	pF
スイッチング時間 Switching Time	上昇時間 Rise Time	V _{CC} = 300V R _L = 1.0Ω R _G = 3.6Ω V _{GE} = ±15V	-	0.15	0.40	μs
	ターンオン時間 Turn-on Time		-	0.30	0.75	
	下降時間 Fall Time		-	0.10	0.35	
	ターンオフ時間 Turn-off Time		-	0.40	0.80	

□ フリーホイールダイオードの特性 : FREE WHEELING DIODE RATINGS & CHARACTERISTICS (T_c = 25°C)

Item	Symbol	Rated Value	Unit
順電流 Forward Current	DC	I _F	A
	1ms	I _{FM}	

Characteristic	Symbol	Test Condition	Min.	Typ.	Max.	Unit
順電圧 Peak Forward Voltage	V _F	I _F = 300A, V _{GE} = 0V	-	1.9	2.4	V
逆回復時間 Reverse Recovery Time	t _{rr}	I _F = 300A, V _{GE} = -10V di/dt = 600A/μs	-	0.15	0.25	μs

□ 熱的特性 : THERMAL CHARACTERISTICS

Characteristic	Symbol	Test Condition	Min.	Typ.	Max.	Unit
熱抵抗 Thermal Impedance	IGBT	Junction to Case (T _c 測定点チップ直下)	-	-	0.12	°C/W
	Diode		-	-	0.24	

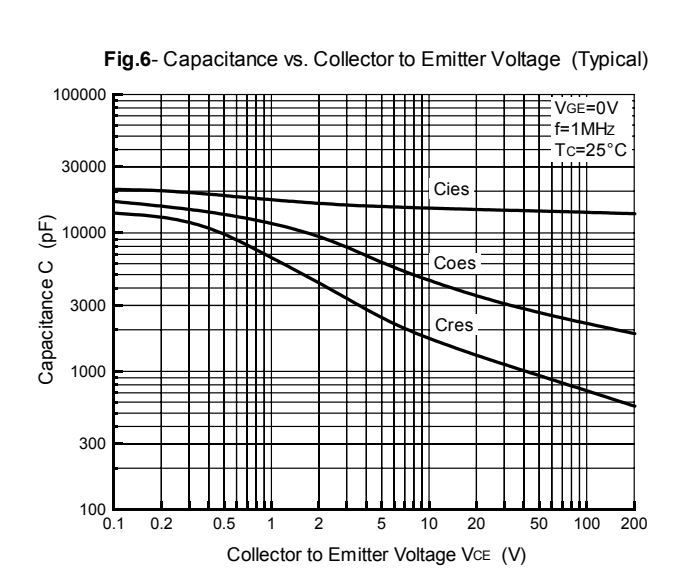
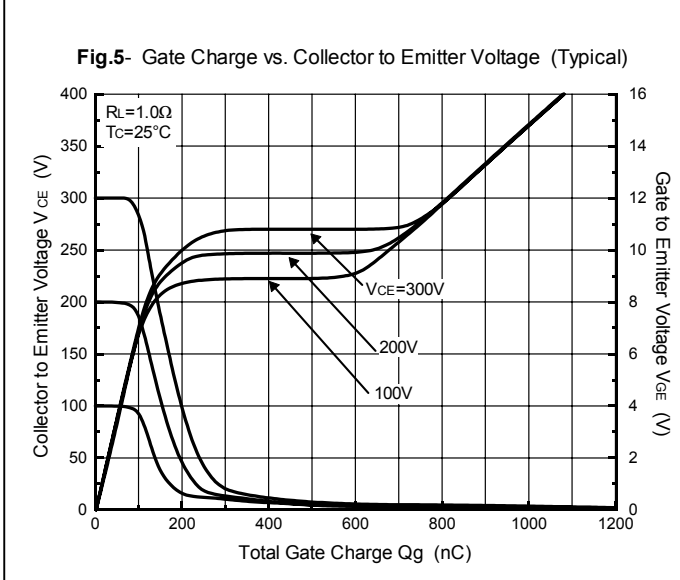
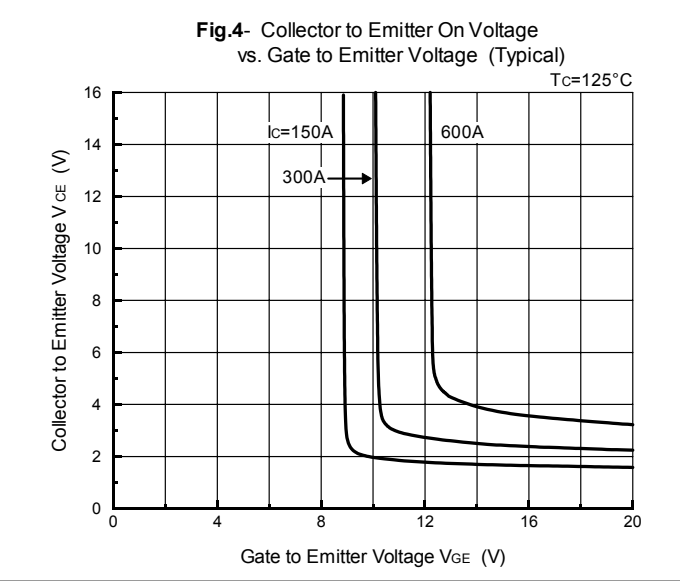
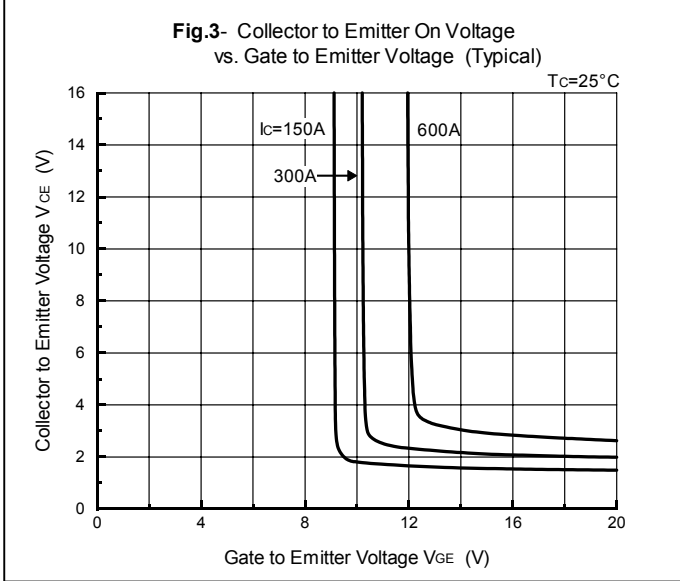
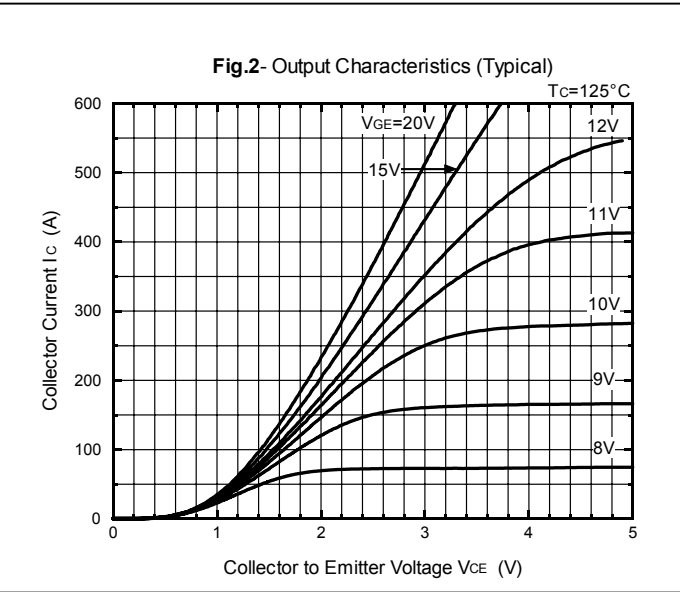
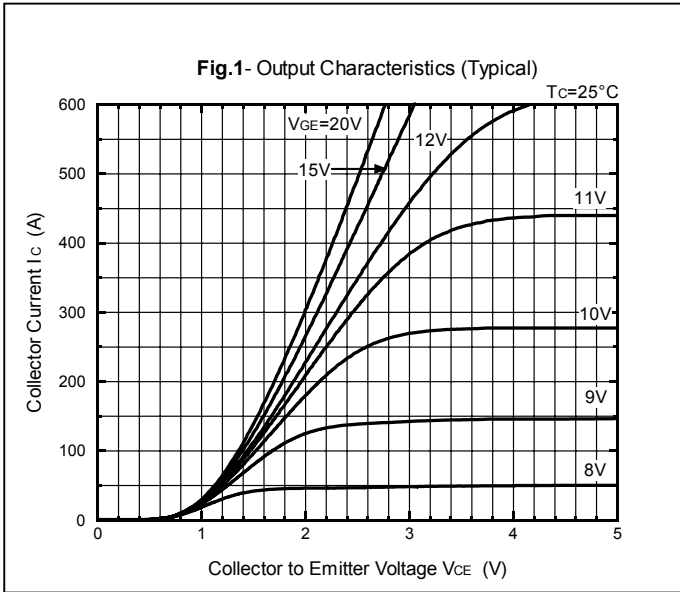

Fig.7- Collector Current vs. Switching Time (Typical)

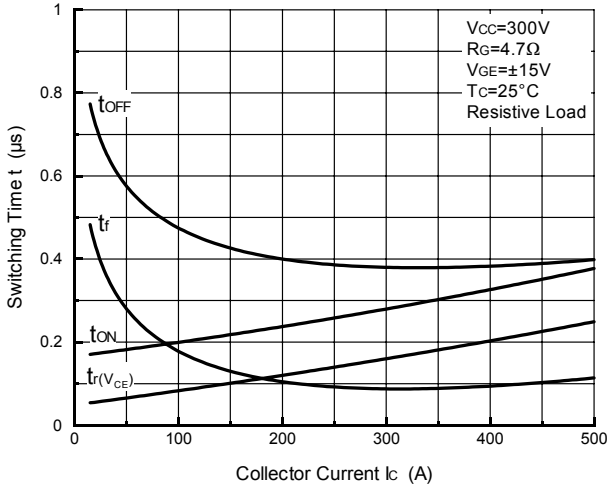

Fig.8- Series Gate Impedance vs. Switching Time (Typical)

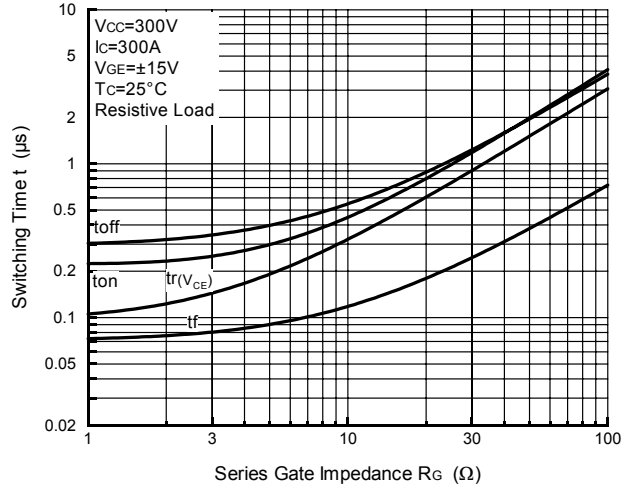

Fig.9- Collector Current vs. Switching Time

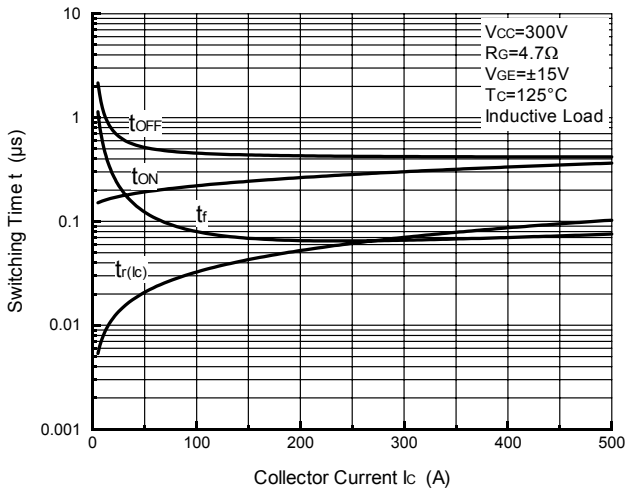

Fig.10- Series Gate Impedance vs. Switching Time

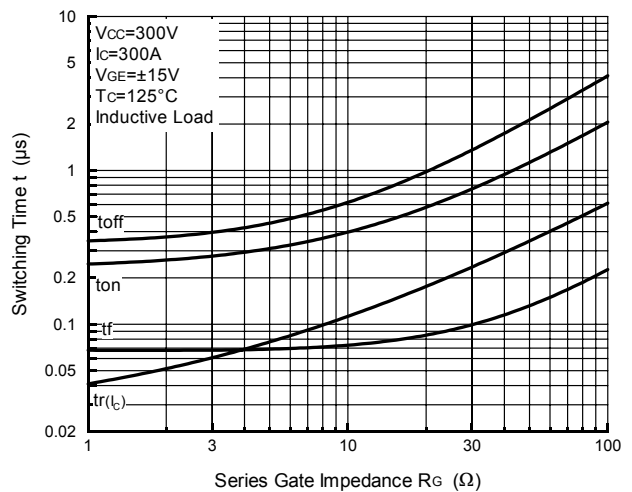

Fig.11- Collector Current vs. Switching Loss

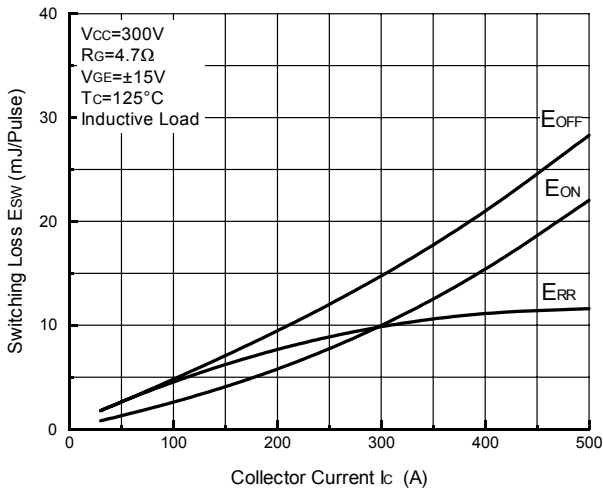

Fig.12- Series Gate Impedance vs. Switching Loss

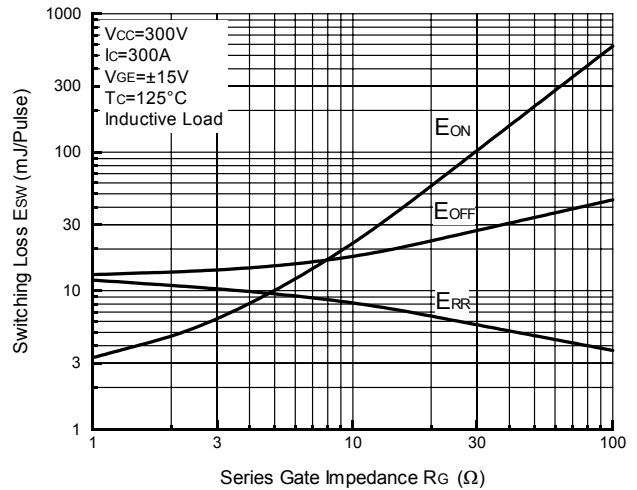

Fig.13- Forward Characteristics of Free Wheeling Diode (Typical)

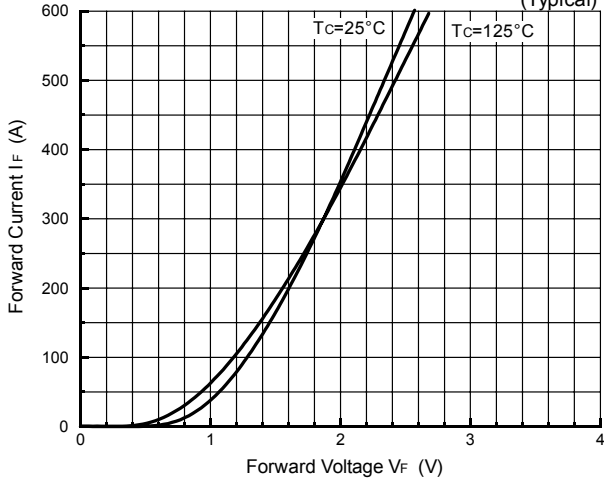

Fig.14- Reverse Recovery Characteristics (Typical)

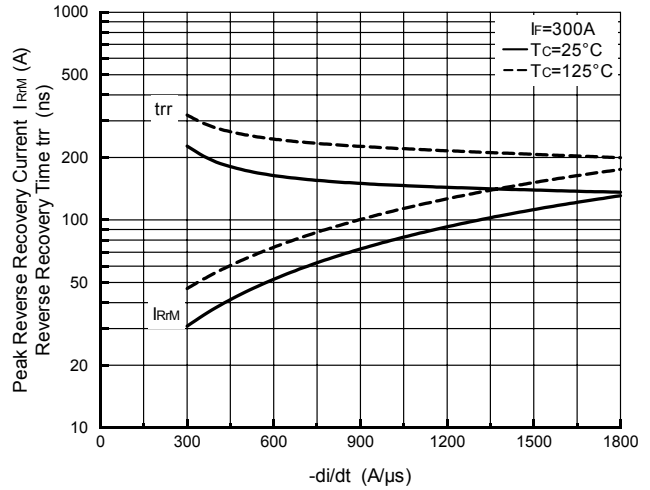

Fig.15- Reverse Bias Safe Operating Area

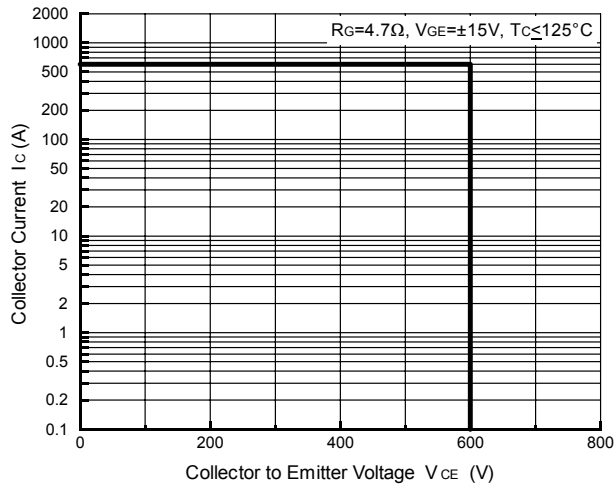

Fig.16- Transient Thermal Impedance

