

IGBT Module-Dual

400 A, 1200V

PDMB400BS12

PDMB400BS12C

回路図 : CIRCUIT

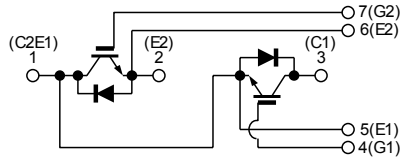

外形寸法図 : OUTLINE DRAWING

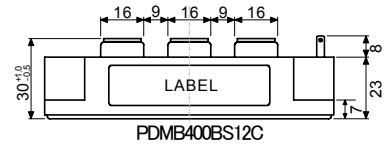
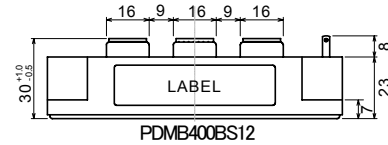
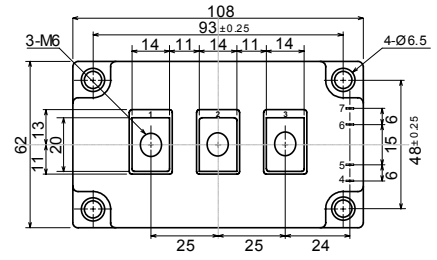
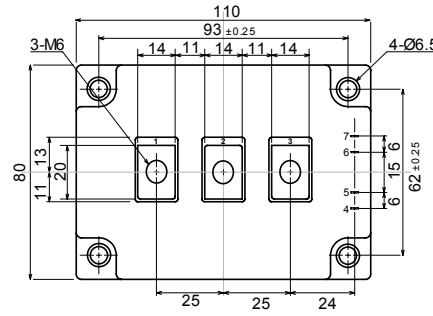

Dimension: [mm]

最大定格 : MAXIMUM RATINGS (T<sub>c</sub> = 25°C)

Item	Symbol	Rated Value	Unit
コレクタ・エミッタ間電圧 Collector-Emittter Voltage	V <sub>CEs</sub>	1,200	V
ゲート・エミッタ間電圧 Gate-Emittter Voltage	V <sub>GES</sub>	±20	V
コレクタ電流 Collector Current	DC	I <sub>C</sub> = 400	A
	1ms	I <sub>CP</sub> = 800	
コレクタ損失 Collector Power Dissipation	P <sub>C</sub>	2,400	W
接合温度 Junction Temperature Range	T <sub>j</sub>	-40 ~ +150	°C
保存温度 Storage Temperature Range	T <sub>stg</sub>	-40 ~ +125	°C
絶縁耐圧(Terminal to Base AC, 1 minute) Isolation Voltage	V <sub>ISO</sub>	2,500	V (RMS)
締め付けトルク Mounting Torque	F <sub>tor</sub>	3 (30.6)	N·m (kgf·cm)

電気的特性 : ELECTRICAL CHARACTERISTICS (T<sub>c</sub> = 25°C)

Characteristic	Symbol	Test Condition	Min.	Typ.	Max.	Unit
コレクタ遮断電流 Collector-Emittter Cut-Off Current	I <sub>CEs</sub>	V <sub>CE</sub> = 1200V, V <sub>GE</sub> = 0V	-	-	4.0	mA
ゲート漏れ電流 Gate-Emittter Leakage Current	I <sub>GES</sub>	V <sub>GE</sub> = ±20V, V <sub>CE</sub> = 0V	-	-	1.0	µA
コレクタ・エミッタ間飽和電圧 Collector-Emittter Saturation Voltage	V <sub>CE(sat)</sub>	I <sub>C</sub> = 400A, V <sub>GE</sub> = 15V	-	2.3	2.7	V
ゲートしきい値電圧 Gate-Emittter Threshold Voltage	V <sub>GE(th)</sub>	V <sub>CE</sub> = 5V, I <sub>C</sub> = 400mA	4.0	-	8.0	V
入力容量 Input Capacitance	C <sub>ies</sub>	V <sub>CE</sub> = 10V, V <sub>GE</sub> = 0V, f = 1MHz	-	25,200	-	pF
スイッチング時間 Switching Time	上昇時間 Rise Time	V <sub>CC</sub> = 600V R <sub>L</sub> = 1.5Ω R <sub>G</sub> = 3.9Ω V <sub>GE</sub> = ±15V	-	0.25	0.45	µs
	ターンオン時間 Turn-on Time		-	0.40	0.70	
	下降時間 Fall Time		-	0.25	0.35	
	ターンオフ時間 Turn-off Time		-	0.80	1.10	

フリーホイールダイオードの特性 : FREE WHEELING DIODE RATINGS & CHARACTERISTICS (T<sub>c</sub> = 25°C)

Item	Symbol	Rated Value	Unit
順電流 Forward Current	DC	I <sub>F</sub> = 400	A
	1ms	I <sub>FM</sub> = 800	

Characteristic	Symbol	Test Condition	Min.	Typ.	Max.	Unit
順電圧 Peak Forward Voltage	V <sub>F</sub>	I <sub>F</sub> = 400A, V <sub>GE</sub> = 0V	-	2.2	2.6	V
逆回復時間 Reverse Recovery Time	t <sub>rr</sub>	I <sub>F</sub> = 400A, V <sub>GE</sub> = -10V di/dt = 800A/µs	-	0.2	0.3	µs

熱的特性 : THERMAL CHARACTERISTICS

Characteristic	Symbol	Test Condition	Min.	Typ.	Max.	Unit
熱抵抗 Thermal Impedance	IGBT	Junction to Case	-	-	0.052	°C/W
	Diode		-	-	0.107	

PDMB400BS12  
PDMB400BS12C

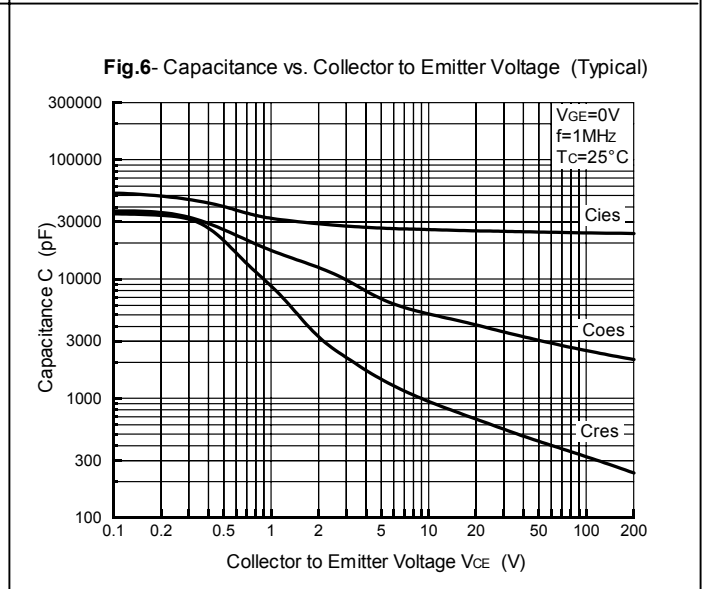
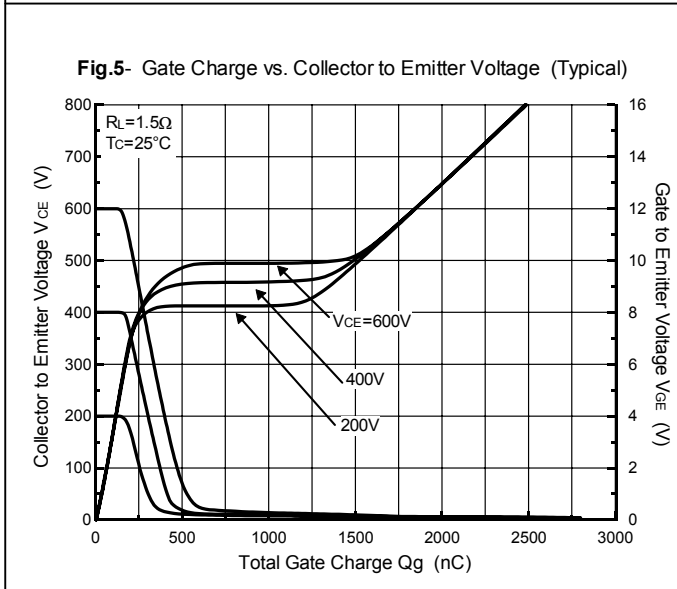
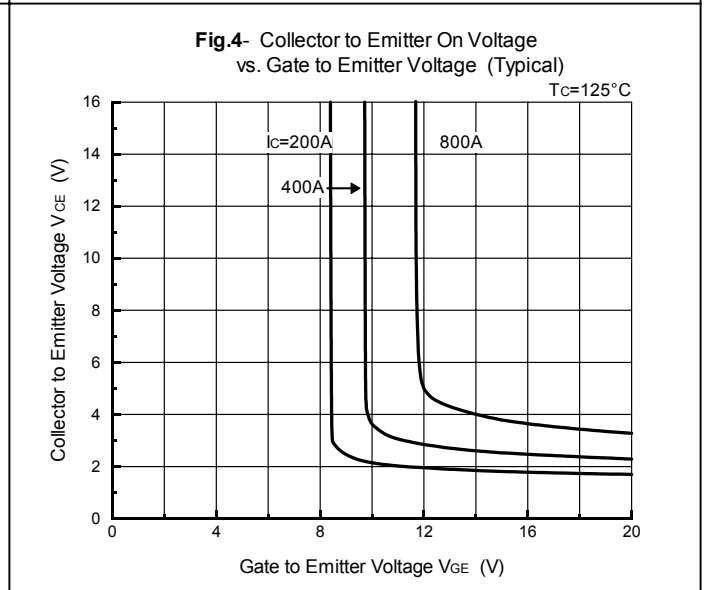
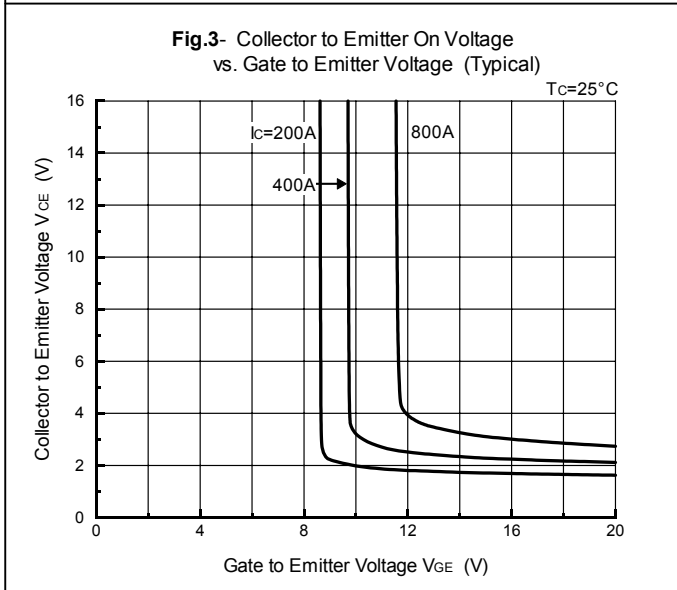
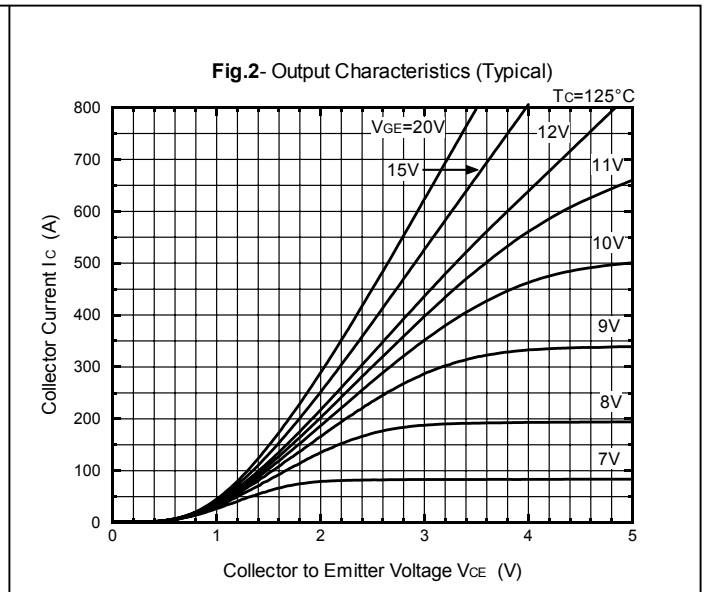
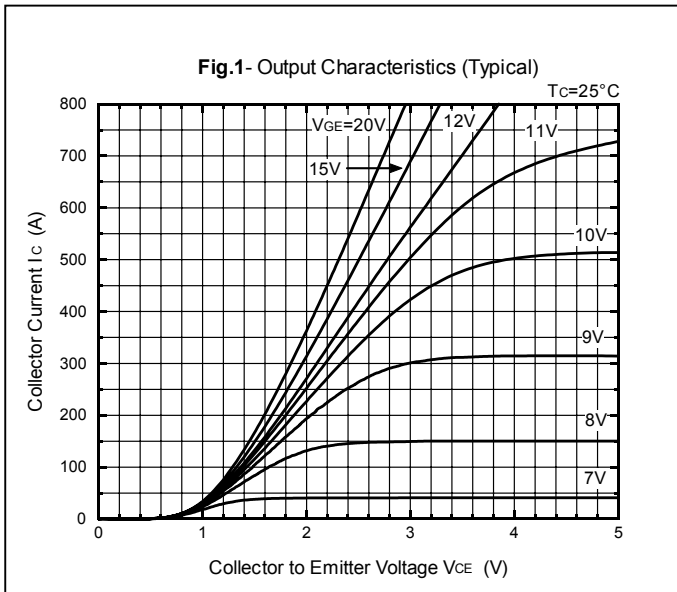

PDMB400BS12

PDMB400BS12C

Fig.7- Collector Current vs. Switching Time (Typical)

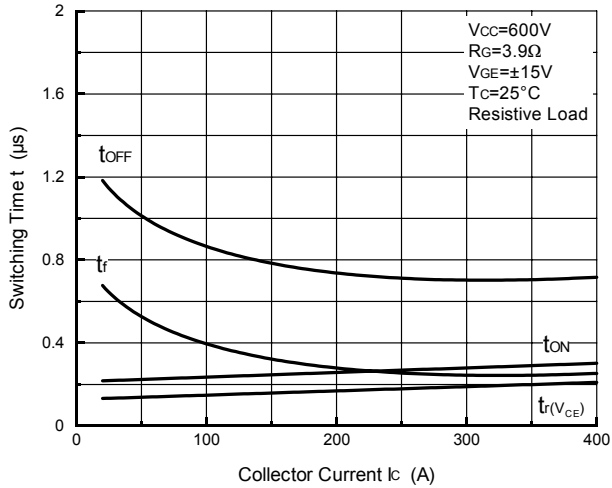

Fig.8- Series Gate Impedance vs. Switching Time (Typical)

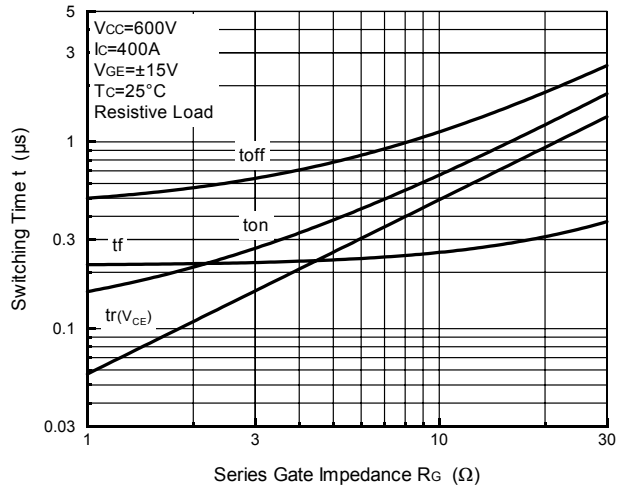

Fig.9- Collector Current vs. Switching Time

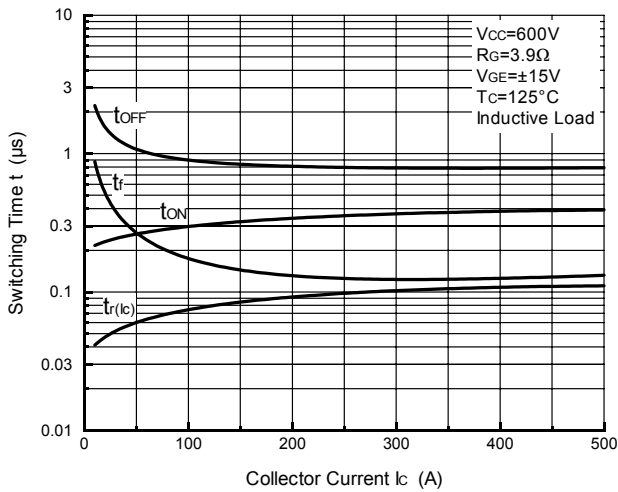

Fig.10- Series Gate Impedance vs. Switching Time

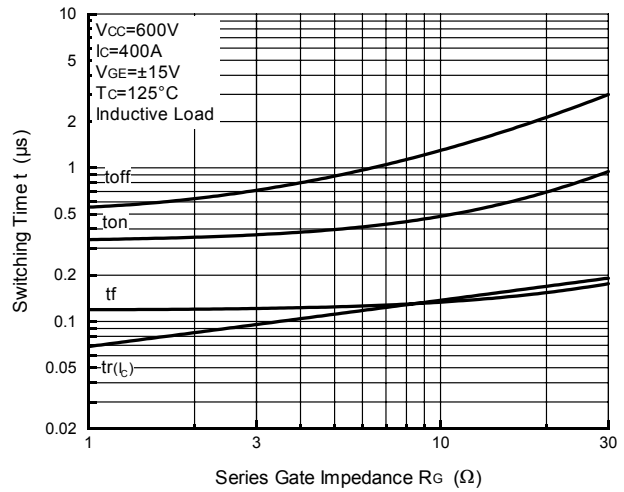

Fig.11- Collector Current vs. Switching Loss

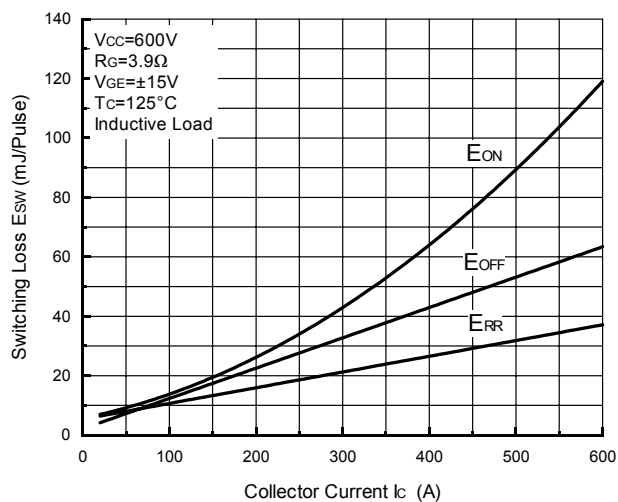
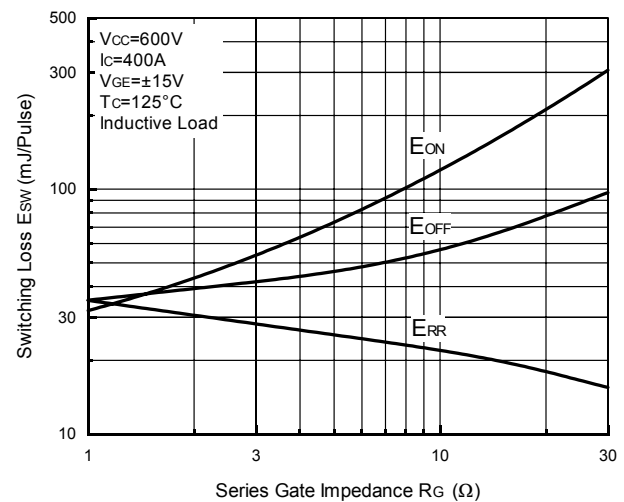

Fig.12- Series Gate Impedance vs. Switching Loss



PDMB400BS12  
PDMB400BS12C

