

□ 回路図 : CIRCUIT

□ 外形寸法図 : OUTLINE DRAWING

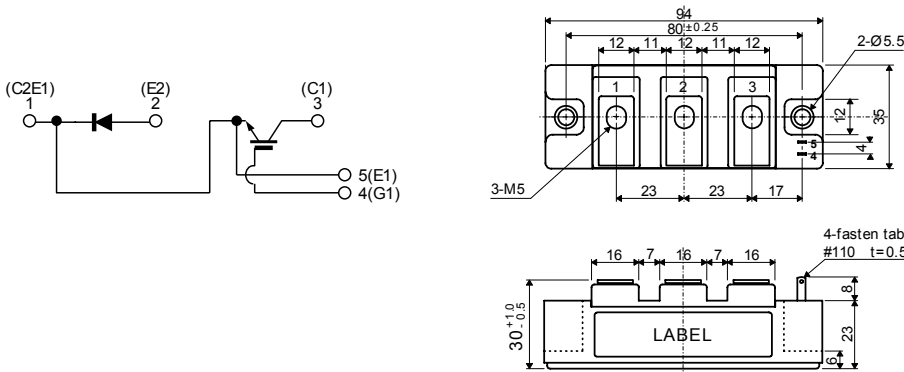

Dimension: [mm]

□ 最大定格 : MAXIMUM RATINGS (T<sub>c</sub> = 25°C)

Item	Symbol	Rated Value	Unit
コレクタ・エミッタ間電圧 Collector-Emitter Voltage	V <sub>CEs</sub>	600	V
ゲート・エミッタ間電圧 Gate-Emitter Voltage	V <sub>GES</sub>	±20	V
コレクタ電流 Collector Current	DC	I <sub>C</sub>	A
	1ms	I <sub>CP</sub>	
コレクタ損失 Collector Power Dissipation	P <sub>C</sub>	400	W
接合温度 Junction Temperature Range	T <sub>j</sub>	-40~+150	°C
保存温度 Storage Temperature Range	T <sub>stg</sub>	-40~+125	°C
絶縁耐圧(Terminal to Base AC, 1 minute) Isolation Voltage	V <sub>ISO</sub>	2,500	V <sub>(RMS)</sub>
締め付けトルク Mounting Torque	Module Base to Heatsink	2	N·m (kgf·cm)
	Busbar to Main Terminal	2 (20.4)	

□ 電気的特性 : ELECTRICAL CHARACTERISTICS (T<sub>c</sub> = 25°C)

Characteristic	Symbol	Test Condition	Min.	Typ.	Max.	Unit
コレクタ遮断電流 Collector-Emitter Cut-Off Current	I <sub>CEs</sub>	V <sub>CE</sub> = 600V, V <sub>GE</sub> = 0V	—	—	1.0	mA
ゲート漏れ電流 Gate-Emitter Leakage Current	I <sub>GES</sub>	V <sub>GE</sub> = ±20V, V <sub>CE</sub> = 0V	—	—	1.0	μA
コレクタ・エミッタ間飽和電圧 Collector-Emitter Saturation Voltage	V <sub>CE(sat)</sub>	I <sub>C</sub> = 100A, V <sub>GE</sub> = 15V	—	2.1	2.6	V
ゲートしきい値電圧 Gate-Emitter Threshold Voltage	V <sub>GE(th)</sub>	V <sub>CE</sub> = 5V, I <sub>C</sub> = 100mA	4.0	—	8.0	V
入力容量 Input Capacitance	C <sub>ies</sub>	V <sub>CE</sub> = 10V, V <sub>GE</sub> = 0V, f = 1MHz	—	5,000	—	pF
スイッチング時間 Switching Time	上昇時間 Rise Time	V <sub>CC</sub> = 300V R <sub>L</sub> = 3.0Ω R <sub>G</sub> = 8.2Ω V <sub>GE</sub> = ±15V	—	0.15	0.30	μs
	ターンオン時間 Turn-on Time		—	0.25	0.40	
	下降時間 Fall Time		—	0.10	0.35	
	ターンオフ時間 Turn-off Time		—	0.35	0.70	

□ フリーホイールダイオードの特性 : FREE WHEELING DIODE RATINGS & CHARACTERISTICS (T<sub>c</sub> = 25°C)

Item	Symbol	Rated Value	Unit
順電流 Forward Current	DC	I <sub>F</sub>	A
	1ms	I <sub>FM</sub>	

Characteristic	Symbol	Test Condition	Min.	Typ.	Max.	Unit
順電圧 Peak Forward Voltage	V <sub>F</sub>	I <sub>F</sub> = 100A, V <sub>GE</sub> = 0V	—	1.9	2.4	V
逆回復時間 Reverse Recovery Time	t <sub>rr</sub>	I <sub>F</sub> = 100A, V <sub>GE</sub> = -10V di/dt = 200A/μs	—	0.15	0.25	μs

□ 熱的特性 : THERMAL CHARACTERISTICS

Characteristic	Symbol	Test Condition	Min.	Typ.	Max.	Unit
熱抵抗 Thermal Impedance	IGBT	Junction to Case (T <sub>c</sub> 測定点チップ直下)	—	—	0.31	°C/W
	Diode		—	—	0.65	

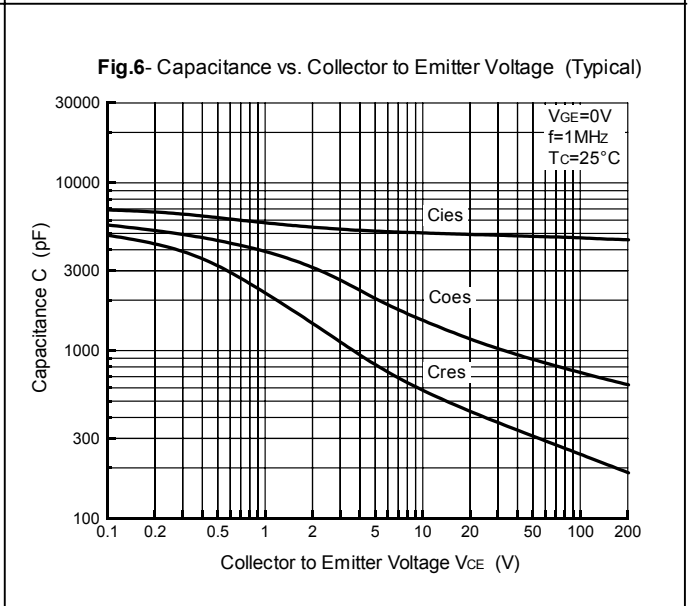
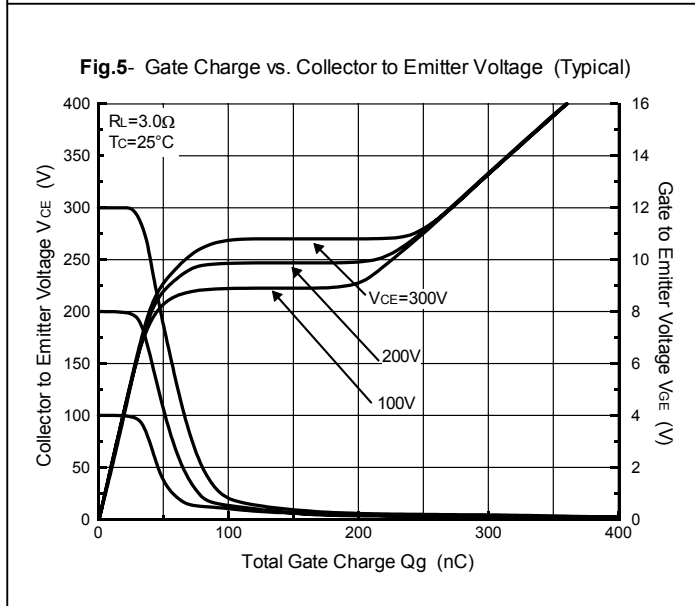
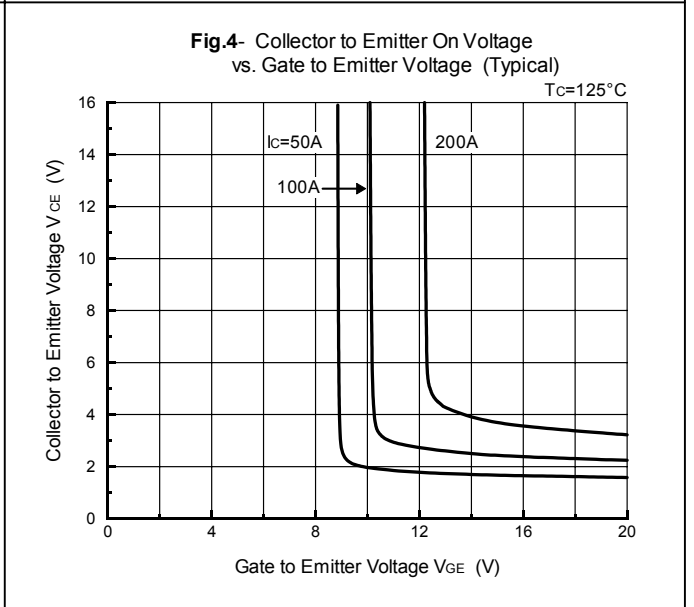
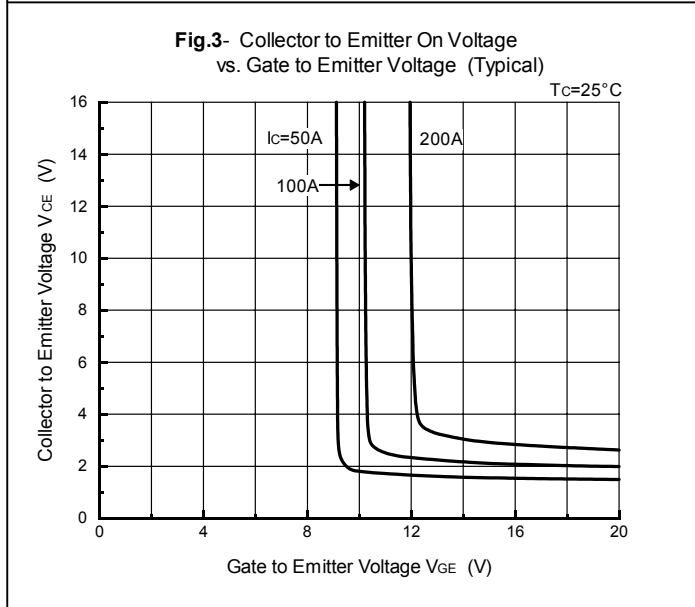
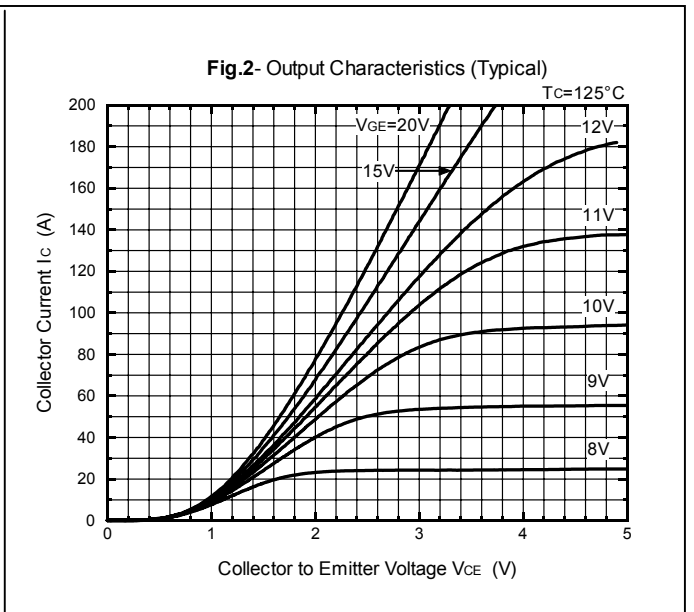
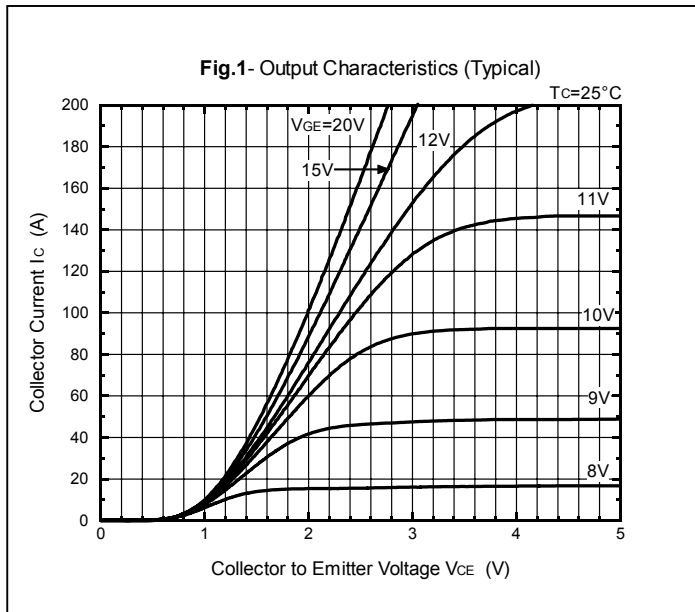

Fig.7- Collector Current vs. Switching Time (Typical)

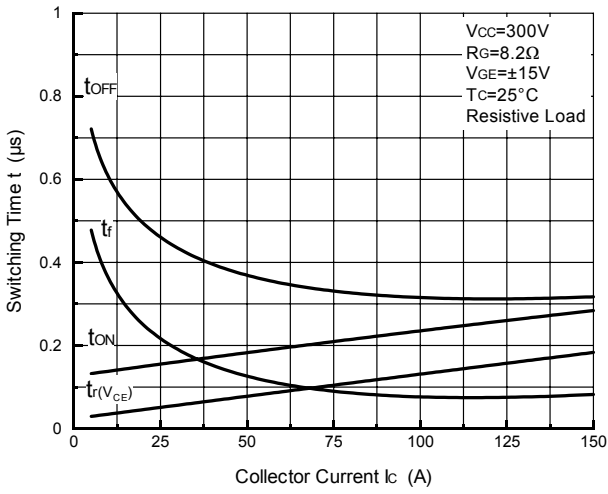

Fig.8- Series Gate Impedance vs. Switching Time (Typical)

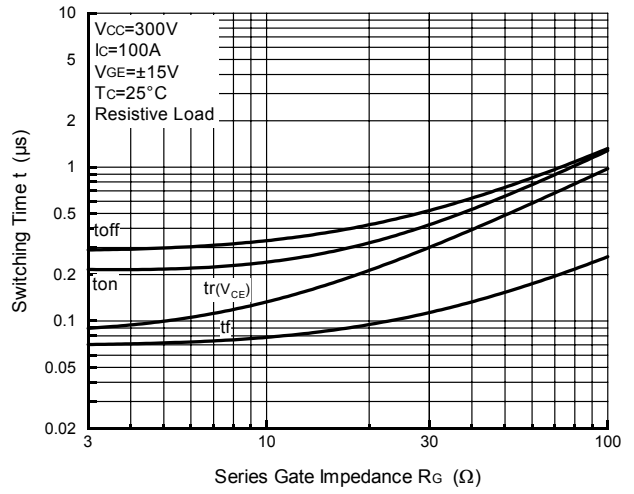

Fig.9- Collector Current vs. Switching Time

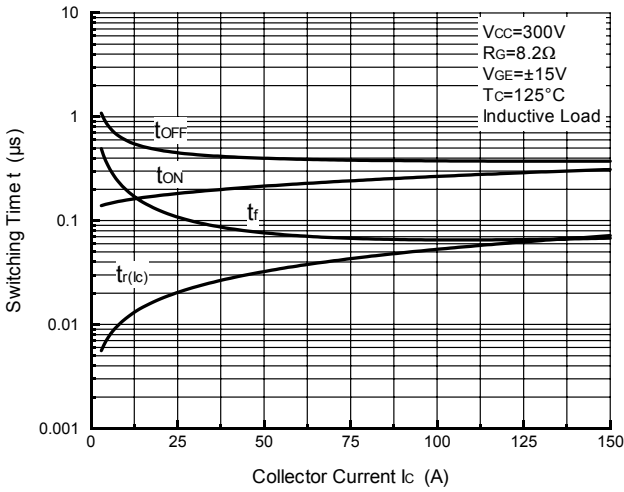

Fig.10- Series Gate Impedance vs. Switching Time

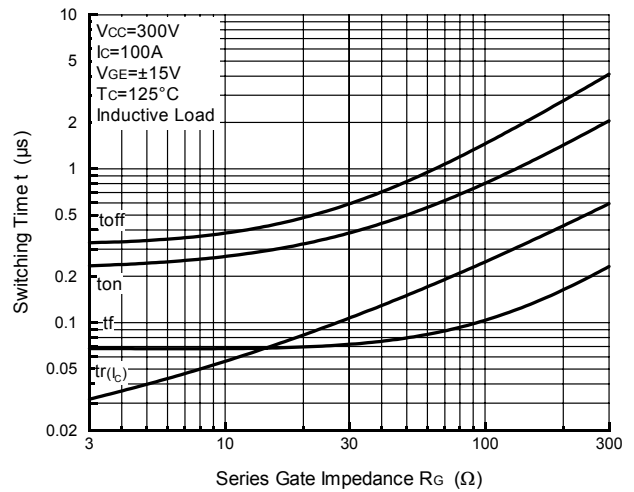

Fig.11- Collector Current vs. Switching Loss

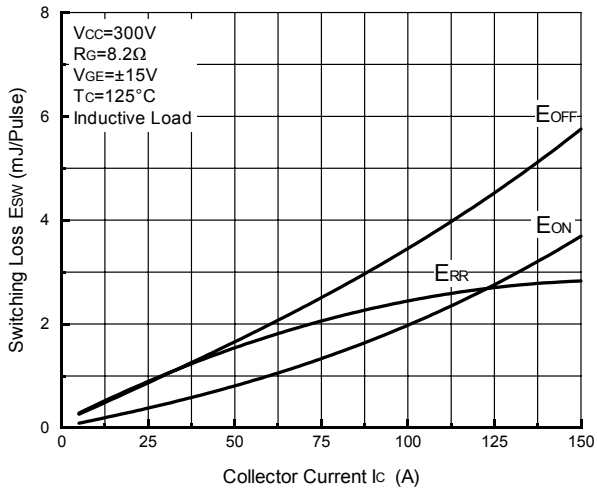
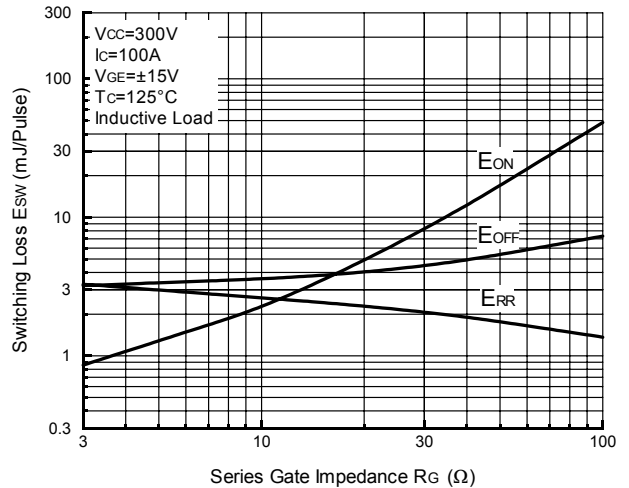
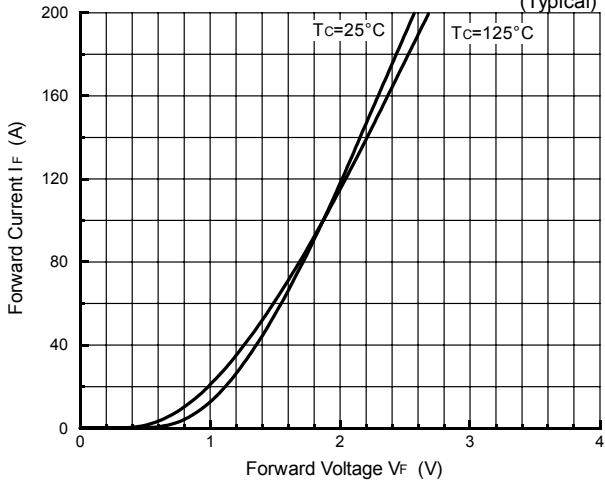

Fig.12- Series Gate Impedance vs. Switching Loss



**Fig.13- Forward Characteristics of Free Wheeling Diode (Typical)**



**Fig.14- Reverse Recovery Characteristics (Typical)**

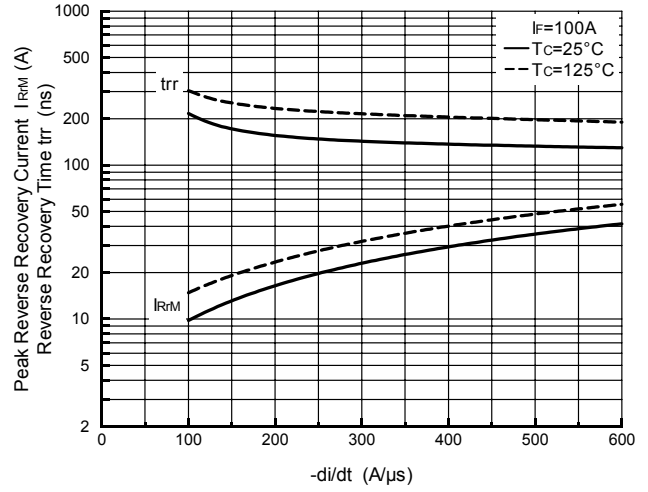

**Fig.15- Reverse Bias Safe Operating Area**

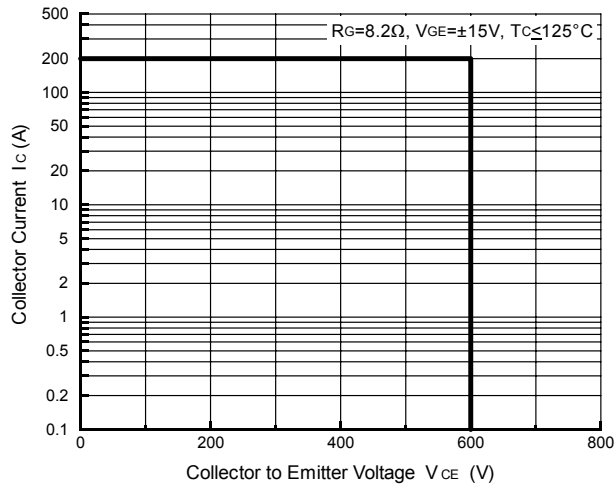

**Fig.16- Transient Thermal Impedance**

