

SBD

80A Avg 200 Volts

P2H80QH20

■回路図 CIRCUIT

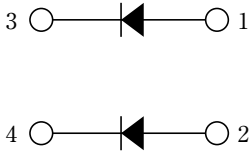

■外形寸法図 OUTLINE DRAWING (単位 Dimension : mm)

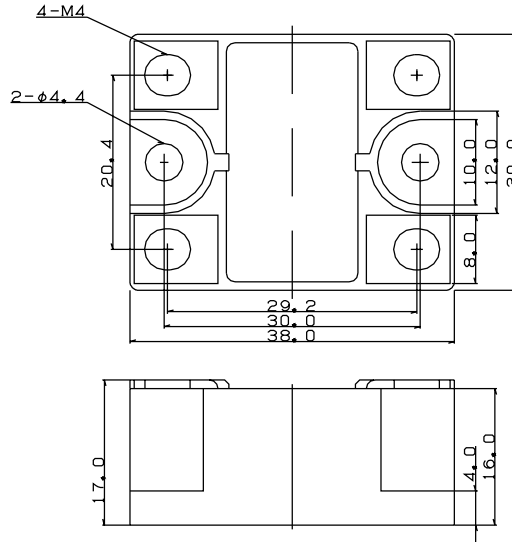

■最大定格 Maximum Ratings

項目 Parameter	記号 Symbol	耐压クラス Grade		単位 Unit
		P2H80QH20		
くり返しピーク逆電圧 *1 Repetitive Peak Reverse Voltage	V _{RRM}	200		V
くり返しピークサージ電圧 *1*2 Repetitive Peak Surge Reverse Voltage	V _{RRSM}	—		V

項目 Parameter	記号 Symbol	条件 Conditions	定格値 Max. Rated Value	単位 Unit		
平均整流電流 *1 Average Rectified Output Current	I _{O(AV)}	商用周波数 180° 通電 T _c = 96°C Half Sine Wave	80	A		
サージ順電流 *1 Surge Forward Current	I _{FSM}	50Hz正弦半波, 1 サイクル, 非くり返し Half Sine Wave, 1Pulse, Non-Repetitive	800	A		
動作接合温度範囲 Operating Junction Temperature Range	T _{jw}		-40 ~ +150	°C		
保存温度範囲 Storage Temperature Range	T _{stg}		-40 ~ +125	°C		
絶縁耐圧 Isolation Voltage	V _{iso}	端子-ベース間, AC 1 分間 Terminal to Base, AC 1 min.	2500	V		
締付トルク Mounting Torque	ベース部 Mounting 主端子部 Terminal	F	サーマルコンパウンド塗布 Greased	M4	1.5 (1.4)	N·m
				M4	1.5 (1.4)	N·m

■電気的特性 Electrical Characteristics

項目 Parameter	記号 Symbol	条件 Conditions	特性値 (最大) Maximum Value	単位 Unit
ピーク逆電流 *1 Peak Reverse Current	I _{RM}	T _j = 25°C, V _{RM} = V _{RRM}	50	μA
ピーク順電圧 *1 Peak Forward Voltage	V _{FM}	T _j = 25°C, I _{FM} = 80A	1.05	V
熱抵抗 *1 Thermal Resistance	R _{th(j-c)}	接合部-ケース間 Junction to Case	0.48	°C/W
接触熱抵抗 Thermal Resistance	R _{th(c-f)}	ケース-フィン間(トータル), サーマルコンパウンド塗布 Case to Fin. (Total), Greased	0.3	°C/W

質量…約35g
Approximate Weight

*1 : 1 アーム当りの値 Value Per 1 Arm.
*2 : Pulse Width ≤ 1 μs, Duty ≤ 1/50

P2H80QH20

■ 定格・特性曲線

順電圧特性
FORWARD CURRENT VS. VOLTAGE

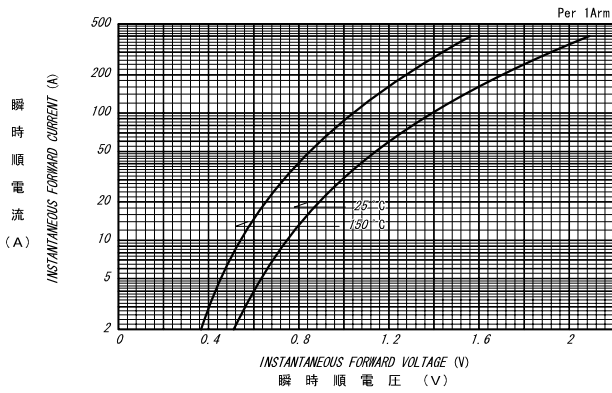

平均順電流 - ケース温度定格
AVERAGE FORWARD CURRENT VS. CASE TEMPERATURE

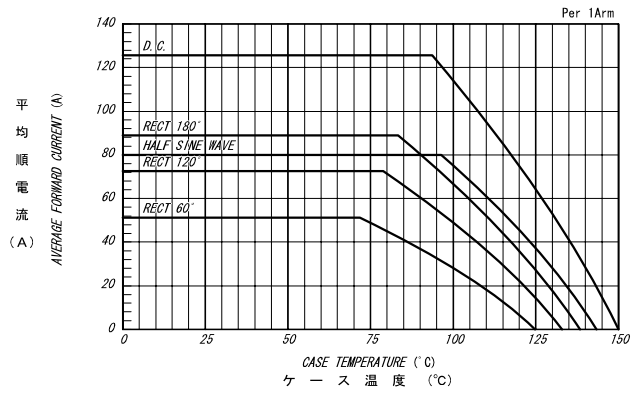

平均順電力損失特性
AVERAGE FORWARD POWER DISSIPATION

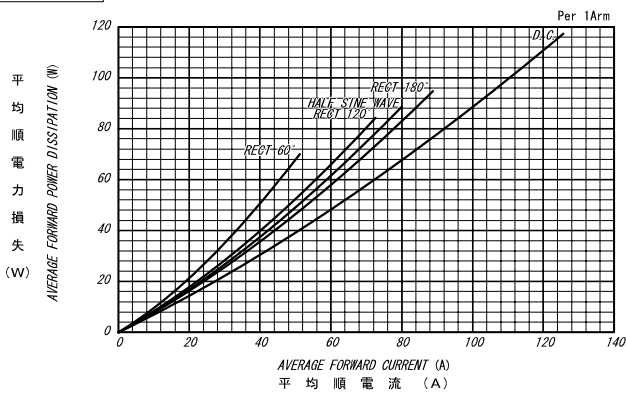

サージ順電流定格
SURGE CURRENT RATINGS

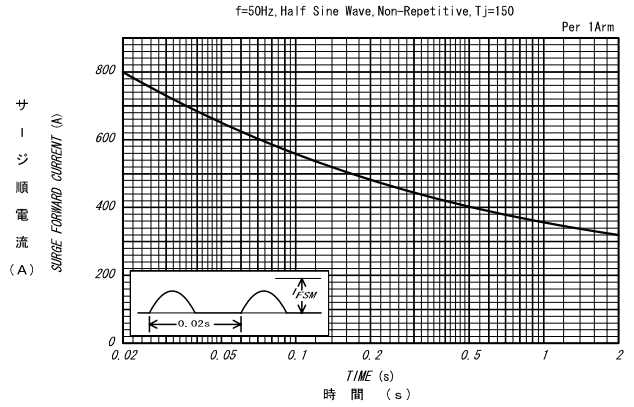

ピーク逆電流 - ピーク逆電圧特性
PEAK REVERSE CURRENT VS. PEAK REVERSE VOLTAGE

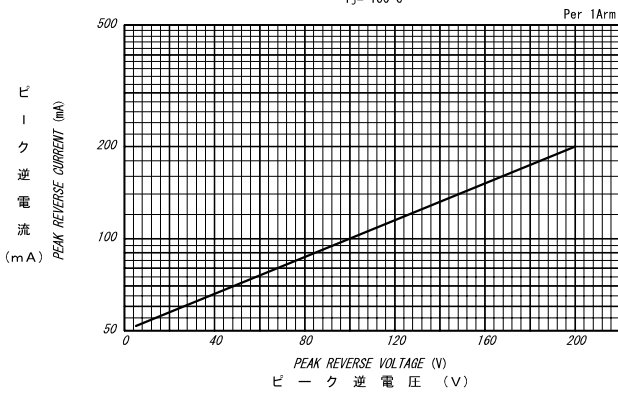

平均逆電力損失
AVERAGE REVERSE POWER DISSIPATION

